

# Melixon-S



①



②



③





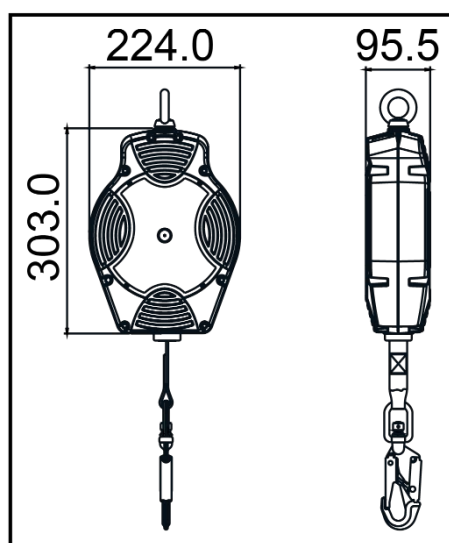
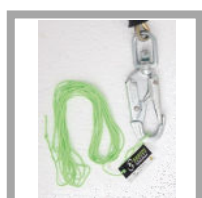



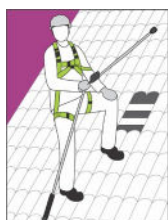

④



<b>HS CODE</b>
84798997
<b>CARTON SIZE / PCS.</b>
60 x 40 x 24 cm / 2
<b>AET (EU) N°2777/10833-01/E01-03</b>
<b>Satra Technology Europe Ltd., N° 2777,</b> Bracetown Business Park, Clonee, Dublin, D15YN2P, Ireland
<b>MODULE D FI14/14003.02</b>
<b>SGS Fimko Oy, N°0598</b> Takomotie 8, 00380 HELSINKI, Finland
<b>AET (UKCA) N°AB0321/16068-01/E02-01</b>
<b>Satra Technology Centre, N°0321</b> Wyndham Way, Telford Way, Kettering Northamptonshire, NN16 8SD, United Kingdom
<b>MODULE D 11 IN14/14003</b>
<b>SGS United Kingdom Ltd., N°0120</b> Unit 202B, Worle Parkway, Weston-super-Mare, BS22 6WA, United Kingdom



REF.	FA 20 504 12
 LG. KG	12 m
	140 KG
 MAT.	Polyamide 6 - 30% fiber glass
	PES 25 mm
	 FA 50 101 17 / FA 50 203 20 with fall indicator
	x2
R(kN)	15 kN
	YES PPE-R/11.060
	6.84 KG



**Longueur** Poids maxi utilisateur  
**Length** Max. user weight  
**Longitud** Peso máximo del usuario  
**Lunghezza** Peso Max. dell'utente  
**Länge** Höchstgewicht des Benutzers

MAT.



**Matière carter / sangle**  
 Material of casing / webbing  
**Material cárter / correa**  
 Material dei carter / Cinghia  
**Material Gehäuse / Gurt**

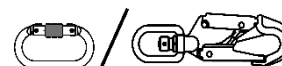

**Matière connecteur haut / connecteur bas**  
 Material of top connector / bottom connector  
**Material conector alto / conector bajo**  
 Materiale connettore alto / connettore basso  
**Material oberes / unteres Verbindungselement**



**Nombre d'émerillons**  
 Number of swivels  
**Cantidad de eslabones giratorios**  
 Numero di tornichetti  
**Anzahl der Wirbel**



**Homologué pour le travail à proximité d'arêtes vives**  
 Approved for work near sharp edges  
**Homologado para trabajo cerca de aristas vivas**  
 Omologato per lavoro in prossimità di spigoli vivi  
**Zugelassen für Arbeiten in der Nähe scharfer Kanten**