

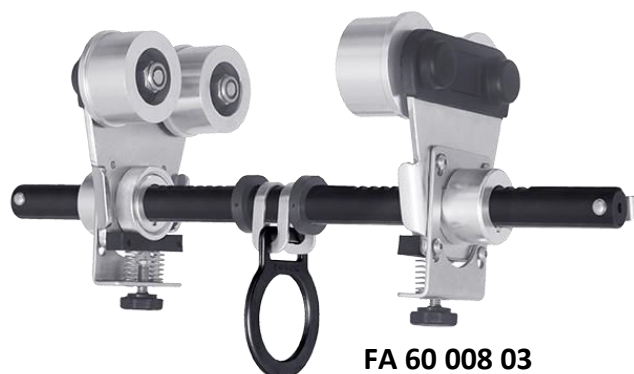





FA 60 008 04



FA 60 008 03



HS CODE
7616999099
CARTON SIZE / PCS.
60 x 40 x 24 cm / 2
AET (UE) N° 2777/10796-02/E01-01
Satra Technology Europe Ltd., N° 2777, Bracetown Business Park, Clonee, Dublin, D15YN2P, Ireland
MODULE D FI14/14003.02
SGS Fimko Oy, N°0598 Takomotie 8, 00380 HELSINKI, Finland
ACKNOWLEDGEMENT OF RECEIPT N°3266/1/2020 (ATEX)
Technická Inšpekcia, a.s. N°1354 Trnavská cesta 56, 821 01 Bratislava, Slovenská Republika

REF.	FA 60 008 03	FA 60 008 04
CE	EN 795:2012 Type B	
	x1	
MAT.		
R (kN) / MBS (kN)	12 kN / 23 kN	
	--- 80 mm → 250 mm	
+	ATEX Directive 2014/34/UE ( II 2 G Exh IIC T6 Gb)	MAX. DIELECTRIC RESISTANCE = 30 kV
	3.90 KG	3.70 KG



Nombre d'utilisateurs
Number of users
Cantidad de usuarios
Cantidad di utilizzatori
Anzahl der Benutzer



Protection diélectrique
Dielectric protection
Protección dieléctrica
Prodotto con protezione dielettrica
Dielektrischer Schutz

R (kN) / MBS (kN)

Résistance statique (en kN) / Résistance à la rupture
Static strength / Minimum Breaking Strength
Resistencia estática (en kN) / Resistencia a la ruptura (en kN)
Resistenza statica (in kN) / Resistenza alla rottura (in kN)
Statische Festigkeit (in kN) / Bruchfestigkeit (in kN)

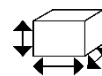

Fixations à utiliser / Dimensions de la structure d'accueil
Fasteners to use / Dimensions of the receiving structure
Fijaciones que deben usarse / Dimensiones de la estructura receptora
Elementi di fissaggio da utilizzare / Dimensioni della struttura ospitante
Zu verwendende Befestigungen / Abmessungen der Aufnahmestruktur