

# MultisafeWay







Ø 23.0 mm

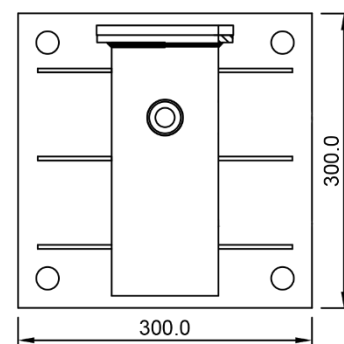
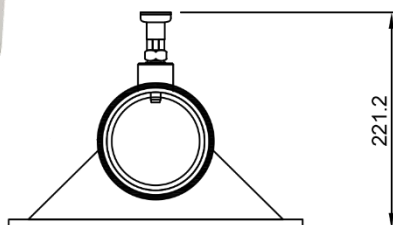

240.0 mm

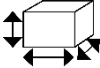

|  |
|--|
| <b>HS CODE</b>   |
| 7610 90 10   |
| <b>CARTON SIZE / PCS.</b>  |
| 34 X 34 X 34 cm / 1  |
| <b>Certificate of test SPC0223656/1414 Issue 3<br/>Extension 1</b>   |
| <b>Satra Technology Centre, N° 0321</b><br>Wyndham Way, Telford Way, Kettering<br>Northamptonshire, NN16 8SD, United Kingdom |
| <b>ACKNOWLEDGEMENT OF RECEIPT N°1120/1/2020</b>  |
| <b>Technická Inšpekcia, a.s. N°1354</b><br>Trnavská cesta 56, 821 01 Bratislava, Slovenská Republika                         |

|  |   |
|--|---|
| REF.   | FA 60 022 02  |
| CE   | EN 795:2012 Type A  |
|    | ---   |
|    | ---   |
| MAT.   |  |
|    | M16 (x4)  |
| R (kN) / MBS (kN)  | ---   |
| +  | ATEX Directive, Machinery Directive<br>360° Rotation (8 positions)                  |
|  | 12.43 KG  |



**Nombre d'utilisateurs**  
Number of users  
**Cantidad de usuarios**  
Quantità di utilizzatori  
**Anzahl der Benutzer**



**Charge maxi admissible**  
Max. allowable load  
**Carga máxima admisible**  
Peso massimale  
**Zulässige Höchstlast**

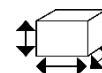

**Fixations à utiliser**  
Fasteners to use  
**Fijaciones que deben usarse**  
Elementi di fissaggio da utilizzare  
**Zu verwendende Befestigungen**