

# Helixon-S

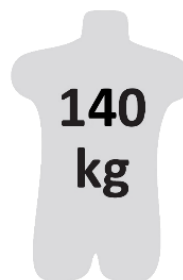

①



②

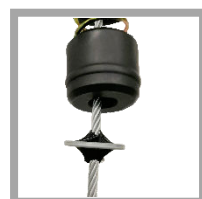

③







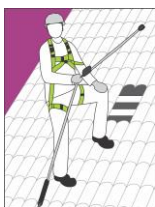
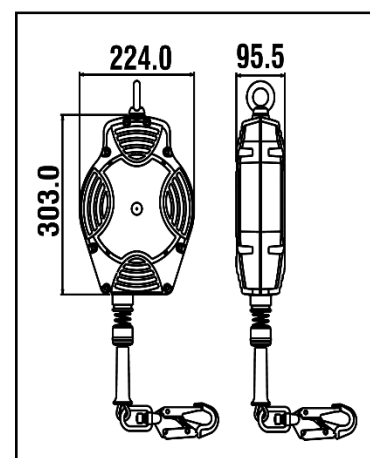

④



⑤



<b>HS CODE</b>
84798997
<b>CARTON SIZE / PCS.</b>
60 x 40 x 24 cm / 2
<b>AET (EU) N°2777/10833-01/E01-03</b>
<b>Satra Technology Europe Ltd., N° 2777,</b> Bracetown Business Park, Clonee, Dublin, D15YN2P, Ireland
<b>MODULE D FI14/14003.02</b>
<b>SGS Fimko Oy, N°0598</b> Takomotie 8, 00380 HELSINKI, Finland
<b>AET (UKCA) N°AB0321/16068-01/E02-01</b>
<b>Satra Technology Centre, N°0321</b> Wyndham Way, Telford Way, Kettering Northamptonshire, NN16 8SD, United Kingdom
<b>MODULE D 11 IN14/14003</b>
<b>SGS United Kingdom Ltd., N°0120</b> Unit 202B, Worle Parkway, Weston-super-Mare, BS22 6WA, United Kingdom

<b>REF.</b>	<b>FA 20 402 15</b>
<b>LG.</b>  <b>KG</b>	15 m
<b>CE</b>	EN 360:2002
<b>MAT.</b> 	Polyamide 6 - 30% fiber glass
	 STEEL Ø4.8 mm
	FA 50 101 17 / FA 50 203 20 with fall indicator x2
<b>R(kN)</b>	12 kN
	YES PPE-R/11.060
<b>+</b>	VG11.060
	8.01 KG

**LG.**  
  
**KG**

**Longueur** Poids maxi utilisateur  
**Length** Max. user weight  
**Longitud** Peso máximo del usuario  
**Lunghezza** Peso Max. dell'utente  
**Länge** Höchstgewicht des Benutzers

**MAT.**  



**Matière carter / câble**  
Material of casing / wire rope  
**Material cárter / cable**  
Material dei carter / cavo  
**Material Gehäuse / Seil**



**Matière connecteur haut / connecteur bas**  
Material of top connector / bottom connector  
**Material conector alto / conector bajo**  
Materiale connettore alto / connettore basso  
**Material oberes / unteres Verbindungselement**



**Nombre d'émerillons**  
Number of swivels  
**Cantidad de eslabones giratorios**  
Numero di tornichetti  
**Anzahl der Wirbel**



**Homologué pour le travail à proximité d'arêtes vives**  
Approved for work near sharp edges  
**Homologado para trabajo cerca de aristas vivas**  
Omologato per lavoro in prossimità di spigoli vivi  
**Zugelassen für Arbeiten in der Nähe scharfer Kanten**